

 **Hoyt** USA®
GET SERIOUS

*Compound Bow
Owners Manual*



TABLE OF CONTENTS

1. Bow Owners Personal Record.....	2
2. Compound Bow Terminology.....	3
3. Important Information.....	4
4. Compound Bow Maintenance Schedule	
Strings and Cables.....	6
Bow Lubrication.....	7
Bow Press Use.....	7
5. Initial Compound Bow Setup	
Rest Selection.....	9
Nock Set Installation.....	10
Cable Guard Installation.....	10
Tiller Adjustment.....	13
Centershot.....	14
Fletch Clearance.....	15
6. Compound Bow Adjustment	
Draw Weight Adjustment.....	15
Draw Length Adjustment.....	16
Inner-Cam Adjustments (Two Cam).....	16
Inner-Cam Adjustments (One Cam).....	17
7. Tuning Your Compound Bow.....	20
8. Compound Bow Warranty.....	22

INTRODUCTION

Welcome to the Hoyt USA family!

As a member of an elite team, you will be pleased to know that you have purchased the finest crafted, most dependable bow on the market. Only the finest components go into every Hoyt USA bow along with over 50 years of experience in bow technology and manufacturing. With some basic maintenance your new bow should provide you with years of pleasure and dependable service.



543 North Neil Armstrong Road
Salt Lake City, Utah 84116-2887
(801) 363-2990 Phone
(801) 537-1470 Fax
www.hoytusa.com

BOW OWNERS PERSONAL RECORD

Fill in the following Personal Bow Record for your later reference.

Bow Serial Number _____

Hoyt USA Bow Model _____

Purchased From _____

Purchase Date _____

Draw Length _____" Draw Weight _____ #

Bowstring Length _____" Cables Length _____"

Important Note:

Save your sales receipt. That receipt is your proof of date-of-purchase. Proof of date-of-purchase will be required should your bow ever need warranty service.

The following space has been reserved for you to staple or tape your sales receipt for safe and convenient keeping. □

IMPORTANT!

Staple or tape your sales receipt here for safekeeping.

COMPOUND BOW TERMINOLOGY

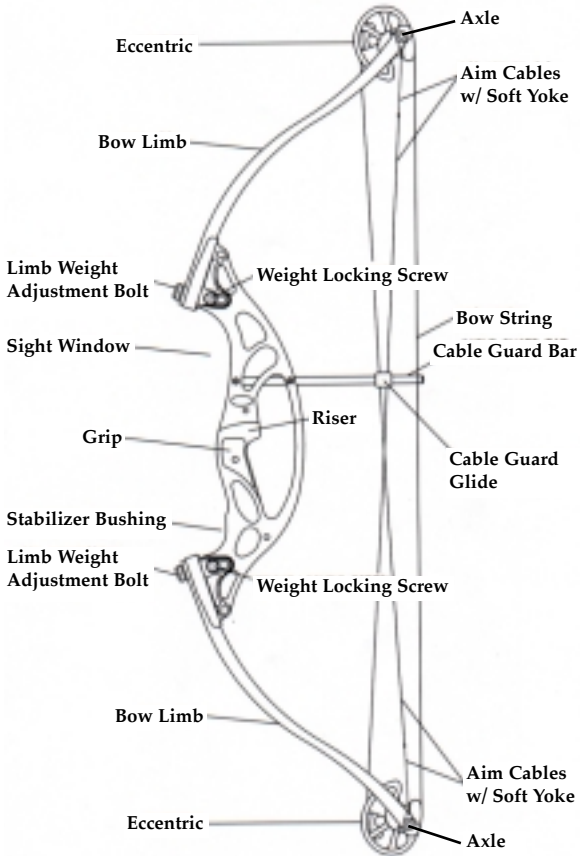

WARNING! YOU'RE RESPONSIBLE FOR ARCHERY SAFETY

Please read the following safety information. Disregarding these rules may cause serious injury to yourself or property.

1. NEVER "DRY FIRE" YOUR BOW. Dry fire means to draw and release the bowstring without an arrow. Firing a bow without an arrow to absorb the energy can cause severe damage to your bow and possible injury to the shooter or others nearby.

2. NEVER EXPOSE YOUR BOW TO EXTREME HEAT OR PROLONGED EXTREME DAMP. Excessive heat, such as that experienced on a sunny day inside a closed vehicle, could cause limb failure. Prolonged storage in a hot dry attic or damp basement could also be damaging.

3. CAREFULLY INSPECT YOUR BOW BEFORE EACH USE. Carefully note the condition of the bowstring, limbs and riser before you shoot. Frayed bowstrings should be replaced. Damaged or suspect limbs should be reported to your local dealer for inspection or replacement.

4. BE SURE OF YOUR BACKSTOP. Make sure that the backstop you use is large enough to catch a stray arrow and that it is thick enough that the arrow cannot completely penetrate it. Make sure that it is positioned in a safe direction away from dwellings and other people.

5. BE SURE OF YOUR TARGET. Make sure that there are no persons, livestock, buildings or other objects behind or near your target. Be absolutely sure of your target in low light conditions.

6. INSPECT ALL ARROWS. Before shooting, inspect your arrows for defects. Discard cracked or dented shafts. Replace damaged or loose fletching and nocks.

7. ALWAYS BE SAFE. Never shoot straight up. Be careful around strings and cables when using broadheads. Cutting strings and cables can cause serious damage to your bow and possible injury to you or others. Children must be supervised by an adult.

8. READ AND HEED ALL WARNINGS. Hoyt USA cannot be held responsible for injuries suffered or caused by misuse, unsafe or improper arrow and bow combinations. Hoyt USA can-

not be held responsible for injuries sustained when using an altered or modified Hoyt USA bow.

WARNING

This bow is a deadly weapon.

Always abide by all safety advisements.

Children should be supervised by an adult.

COMPOUND BOW MAINTENANCE

Your bow is a mechanical device and as such, is subject to wear and need of periodic inspection, adjustment and service. Hoyt USA recommends that you take your bow to an authorized pro shop at least once a year for a yearly professional maintenance and inspection. Areas to be inspected are axles, spacers, lubrication of axle bushings, e-clips, strings, cables, limbs and riser. The following information provides helpful instruction on the proper care and maintenance of your new Hoyt bow. Keep this manual as a handy guide for future reference.

STRINGS AND CABLES

Apply a light coat of bowstring wax to your bow's cables and string on a regular basis. Hoyt USA suggests once every two weeks during peak use. Use a high quality bowstring wax available at your local Hoyt Pro Shop..

This will keep your bow's string and cables in good condition. To assure best results replace D-75 string and cables when wear is evident or every two years under normal use conditions. Insist that Hoyt USA string and cables be used on your bow. Beware of lesser quality string and cables as they may alter the performance of your bow or cause damage to it.

ECCENTRIC LUBRICATION

A light, spot lubrication of the axles where they pass through the eccentric should be done on a regular basis (1,500- 2,000 shots). In adverse hunting conditions where dirt, dust or moisture are encountered, lubrication may be done on a daily basis. Hoyt USA recommends you use a silicone or Teflon based lubrication or any other quality grease available at your local Hoyt USA Pro Shop. It is not recommended that you use "Penetrating Oils" such as WD-40, EZ-#7, Fast Break, etc.

BOW PRESS USE

Never allow your bow to be put into a bow press unless it is operated by a knowledgeable bow technician. Hoyt USA recommends that all necessary adjustments requiring the use of a bow press be done by an authorized Hoyt Pro Shop.

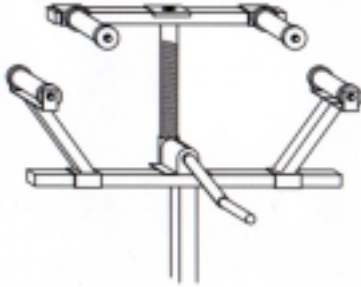

fig 1 (An Example of a Double Pull Bow Press)

Always use a double bow press like that shown in figure 1 when working on your bow.

Never use a single pull bow press. (See fig 2)

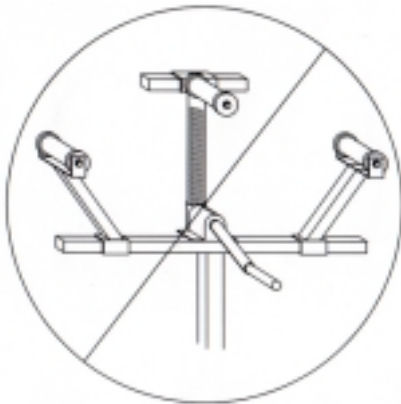

fig 2 (An Example of a Single Pull Bow Press)

When putting your bow in a bow press, **never put pressure on the riser!** Always position the rollers at the base of the limbs (where the limbs enter the limb pockets).

COMPOUND BOW SETUP

REST SELECTION

There are two basic types of arrow rests “Shoot Through” and “Shoot Around” (See fig 3) Shoot through rests are designed for release shooters as arrows shot using a release bend vertically. Shoot around rests are designed for finger shooters as arrows shot by fingers bend horizontally. Hoyt USA recommends that you seek the advice of a qualified Pro Shop for the proper rest selection for your style of shooting.



fig 3 Shoot Through

Shoot Around

NOCK SET INSTALLATION

A nock point is a reference on the string that marks the exact location for you to nock your arrow. The arrow's nock is positioned under the nock set. To install the nock set at the proper position begin by slipping the nock set on the string. Then, using your rest as a reference, position the nock set just above level. A finger shooter should initially position the nock set at approximately $3/8''$ above level. The release shooter should begin at approximately $1/4''$ above level. (See fig 4) Once the nock set is at the desired location use a special set of nocking pliers to crimp the nock set into place. **NEVER** shoot a bow without a nock set or with a nock set that has not been properly crimped. For proper installation Hoyt USA recommends that this be done by a qualified Pro Shop.

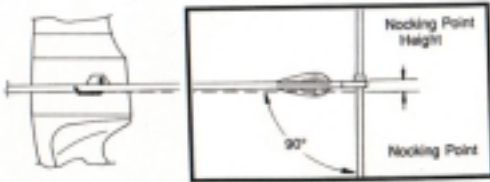

fig 4

CABLE GUARD INSTALLATION

All aluminum Hoyt USA bows are designed with a built in cable guard bar attachment. To

insert the cable guard bar, simply slide the bar into the two mounting holes on the riser making sure that the bar is pushed completely through and flush with the end of the front mounting hole. After the bar has been inserted fasten with the 8-32 x 1/2 screws provided. (See fig 5)

8-32NC Screws SHCS

Flush w/Front of Riser



fig 5

Hoyt USA's magnesium bows are designed with a high mount style cable guard bar that is mounted directly to the side of the riser by two 10-24 screws. (See fig 6)

10-24 SHCS
Screws

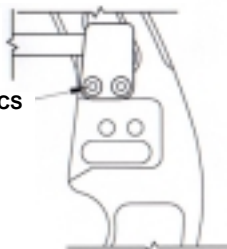

fig 6

All of Hoyt USA's aluminum target bows come with an adjustable stainless steel cable guard bar. **Warning!** On some shorter axle to axle models, adjustable cable guard bars can be off-set too much

causing the cable to track off the cam. This can cause damage to the bow or personal injury. To prevent this from happening, NEVER SET THE BAR AT THE THREE O' CLOCK POSITION.

CABLE GUARD GLIDE INSTALLATION

Hoyt USA uses a specially designed cable glide that has off-set cable slots. To correctly install the glide on two-cam, VersaCam, and Redline Cam model bows, make sure that when the cables are inserted into the glide the shortest slot is to the rear and the longer slot closest to the grip. For all SaberCam model bows, make sure that the longest slot is to the rear and the shorter slot is closest to the grip. (See fig 7)

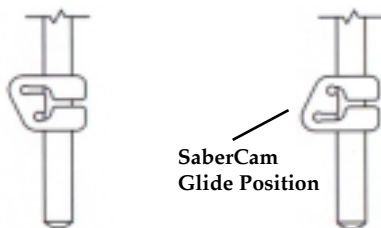

fig. 7

Note: If you have trouble pulling the cables back far enough to get the glide over the end of the cable guard bar, you will need to use a bow press. Hoyt USA recommends that the cable

guard glide installation be done at a Pro Shop.
CAUTION: Do not pull bow back without proper installation of cable guard bar and glide.

TILLER ADJUSTMENT

Tiller is the difference in actual distance between the upper limb to the string and lower limb to the string measured from the base of the limbs (where the limb and riser meet) at a 90 degree angle. (See fig 8)



fig. 8

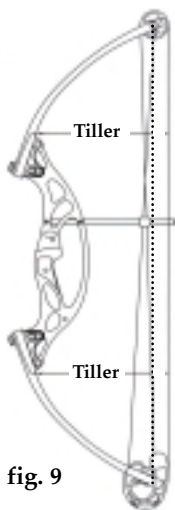

fig. 9

Single cam models must be measured from a ref-

erence line from axle to axle. (See fig 9)

The main function of tiller is to allow the archer to more easily and comfortably aim during the draw and release of the shot. Most bows will shoot best with an even tiller which means the distance from the string to the limb is the same on top and bottom. Tiller adjustments are made by adjusting either limb weight adjustment bolt. (See draw weight adjustment section). Example: Too much tiller on the bottom limb, decrease the weight on the top limb or increase the weight on the bottom. Hoyt USA recommends that you initially set tiller equal top and bottom.

CENTERSHOT

Centershot is the alignment of the arrow in the power path of the string. This is accomplished by moving the arrow rest left or right.

Release shooters should line the arrow up with the power path of the string. (See fig 10) Finger shooters should position the arrow so that the tip is just to the outside of the power path of the string. (See fig 10)

Centershot is critical to how accurate a bow will perform. These are initial centershot settings, for proper alignment Hoyt USA recommends this be done by a qualified Pro Shop.

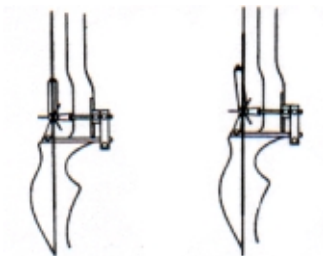

fig 10 Release Setting Fingers Setting

FLETCH CLEARANCE

Fletch clearance is the ability of your vanes or fletchings to pass cleanly by or through your arrow rest without impacting the rest so severely that the arrow's flight path is disrupted. It is necessary that you have adequate vane clearance to achieve proper arrow flight. (See fig 11)

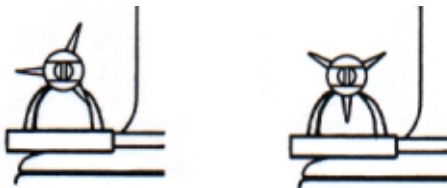

fig. 11 Incorrect Correct

COMPOUND BOW ADJUSTMENT

DRAW WEIGHT ADJUSTMENT

Weight adjustments can easily be made by turning the weight adjustment bolt clockwise to increase weight

or counter clockwise to decrease weight. Note: Always turn the top and bottom adjustment bolts in equal amounts. Some Hoyt USA model bows are equipped with a Dual Locking Pocket System. Before draw weight adjustments are made on these models you must first loosen the Locking Pocket screws located on the side of the pocket. (See fig 12) When adjustments are completed, re-tighten the Locking Pocket screws.

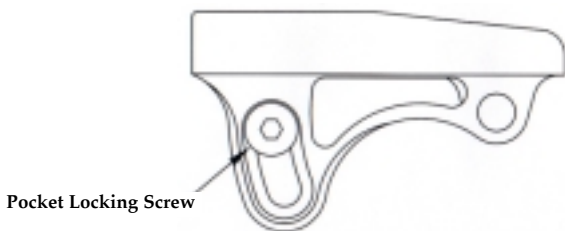

fig 12

DRAW LENGTH ADJUSTMENT

Some of the cams and wheels offered by Hoyt USA have an InnerCam Adjustment System. The InnerCam module is moved to a different position on the cam to change draw length. Bows equipped with the InnerCam System can generally be adjusted without the use of a bow press.

TWO-CAM DRAW LENGTH ADJUSTMENT

To adjust the draw length on Hoyt's two cam (innercam) model bows, use a standard allen key to loosen the fastening screw. (See fig 13) Then using the same allen key, remove the Draw Length screw. (See fig 13)

Rotating the inner-cam in the (+) direction will lengthen the draw. Rotating the inner-cam in the (-) direction will shorten the draw. Once the inner-cam is in the desired location, retighten the Draw Length screw first and then the Fastening Screw. Note: You must make the same adjustments to the top and the bottom inner-cams or the bow cannot be properly tuned.

Finer adjustments can be made by twisting the string and cables. Special care must be taken when twisting the string and cables as they can be twisted in the wrong direction. Hoyt USA recommends that these adjustments be made by a qualified Pro Shop.

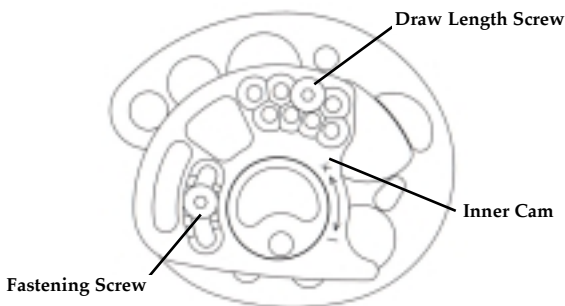

fig 13

ONE-CAM DRAW LENGTH ADJUSTMENT

Hoyt USA Single cam bows with an inner-cam system also include a built-in draw stop peg. Therefore, when adjusting the draw length on inner-cam single

cam bows both the module and the draw stop peg must be adjusted. When the module is rotated completely to the minus (-) sign, the cam will be in the "A" draw stop peg setting, or the shortest draw length. By rotating the module in the direction of the plus (+) sign, you will increase the draw length approximately 1/2 inch per each hole, and each hole represents the next higher letter. For example, if the module is rotated completely to the minus sign which is module position "A", and you then rotate it to the plus (+) sign, the first hole available for the module screw is module position "B" or an increase in draw length of 1/2 inch. (See figure 14 for diagram).

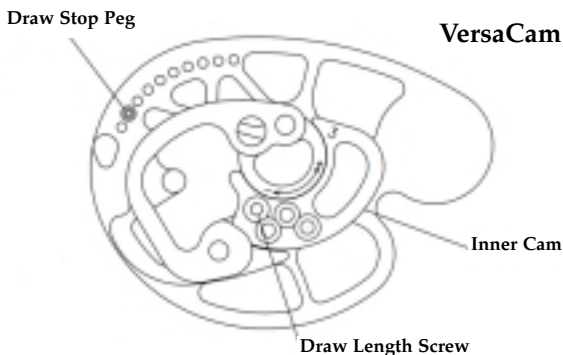

fig 14

All inner-cam single cams are marked with a size 1 - 3. The charts on the next two pages show peg position in relation with module position depending on the size of the cam. Please follow charts closely to achieve the greatest performance from your cam. Each recom-

mended peg position represents a 70% let-off for the cam. Moving the peg one hole less than the recommended position will decrease the let-off to 65%. Moving the peg one hole more than the recommended position will increase the let-off to 75%. Moving the peg more than one hole in each direction is not recommended and will significantly change the feel of the wall.

VERSACAM #1 CHART

Module Position	Peg Position
A	3
B	4
C	4
D	5
E	5
F	6
G	Remove Peg
H	Remove Peg

VERSACAM #2 CHART

Module Position	Peg Position
A	3
B	5
C	6
D	6
E	7
F	8
G	9
H	Remove Peg

VERSACAM #3 CHART

Module Position	Peg Position
A	2
B	4
C	5
D	6
E	7
F	8
G	9
H	Remove Peg

Note: A compound bow is a complete interdependent system. Changing draw length may effect your bow's draw weight. Your bow may loose peak weight that may not be completely recoverable.

TUNING

To tune your bow have on hand three fletched arrows and three bare shafts, all identical and straight. From about 15 to 20 yards shoot your fletched arrows, making necessary sight adjustments to hit the target at the same spot each time. Once you have sighted in, shoot the three bare shafts and note where the group of bare shafts are compared to the fletched arrows.

If the bare shafts are grouping below the fletched arrows, lower the nocking point. (See fig 14) If the bare shafts are grouping above, move the nock point up. (See fig 15) Be sure to only move in small incre-

ments (never more than 1/16" at a time). Each time the nocking point is moved it will affect your sight setting, so you will have to re set your sights after each move. Continue to make adjustments until both groups are relatively close together. If the bare shafts hit to the right of the fletched arrows decrease bow weight, check for vane clearance or check arrow spine stiffness (weak). (See fig 16) If the bare shafts group to the left, increase bow weight, check for vane clearance or check arrow spine stiffness (stiff). (See fig 17). Some adjustments can be made slightly moving the arrow rest to the left of the right. Note: Left handed shooters need to reverse these instructions for left and right results. Hoyt USA recommends that you work closely with your local Pro Shop when tuning your bow to ensure best results.



fig 14



fig 15



fig 16



fig 17

TUNING WITH BROADHEADS

Most archers discover that they must make slight tuning adjustments when switching from practice points to broadheads (even at the same weight). Broadheads create a dramatic aerodynamic change in arrow flight. For this reason, slight adjustments may need to be made in nocking point height, rest position or bow weight to achieve perfect broadhead flight.

HOYT USA COMPOUND BOW WARRANTY

All Hoyt USA compound bows are warranted against defects in materials or workmanship to the original owner on aluminum risers, limb pockets, and eccentrics for the life of the product. Compound limbs will be warranted for three (3) years.

ACCESSORIES

All Hoyt USA sights (excluding sight pins), arrow rests, and bow quivers (excluding hood foam and arrow gripper) are warranted 100% for the life of the product to the original owner. Hoyt USA must perform warranty work.

You must have the following items in order to obtain warranty work:

1. A dated proof of purchase (sales receipt).
2. Products must be purchased through a Hoyt USA authorized dealer (no exceptions!)
3. All compound bows must have a serial number.

Hoyt USA, at its discretion, voids all warranty claims either expressed or implied including but not limited

to evidence of abuse, modification to original design, use attachments or accessories that cause excessive stress.

Hoyt USA reserves the right to make substitutions on warranty coverage at Hoyt USA's discretion for any reason. Warranty is subject to available parts.

OBTAINING WARRANTY SERVICE

To obtain warranty service, you should return to the Pro Shop where you purchased your Hoyt USA bow. The dealer can help to determine if Hoyt USA factory service is required or if the repair can be completed by the Pro Shop. If the bow must be returned to the factory, the bow owner is responsible for the return freight to Hoyt USA. Hoyt USA, in turn, will pay for the same return freight of the repaired product.

Before any bow is returned a **Return Authorization** number must be obtained through an authorized Hoyt USA Pro Shop. Bows returned to the factory without a Return Authorization number will be sent back. Do not send accessories with bow unless otherwise instructed to.

Hoyt USA bows requiring factory service should be sent to:

Hoyt USA
543 N. Neil Armstrong Road
Salt Lake City, UT 84116

There are no other warranties expressed or implied that extend beyond those written here. No agent, employee or representative of Hoyt USA or its dealers has the authority to bind Hoyt USA to any agreement not herein stated. Buyer agrees that the sole and exclusive remedies for breach on any warranty concerning Hoyt USA bows shall be repair or replacement of defective parts. Hoyt USA shall not be liable for injury or property other than the bows themselves. Hoyt USA reserves the right to replace defective parts according to availability with compatible replacement parts.

NOTES

WARRANTY REGISTRATION CARD

(Or register on-line at www.hoytusa.com)

Bow Model _____

Bow Serial Number _____

(Located in rest plate area)

Owner's Name _____

Address _____

City _____ State ____ Zip _____

E-Mail Address _____

Place of purchase _____

Date of purchase _____

How many years have you shot? 0-5 5-10 10 +

Is this your first Hoyt bow? YES NO

Why did you select this bow? _____

Will you hunt with this bow? YES NO

How many days a year do you hunt?

0 - 10

10 - 20

20 +

What are the top three Species of animals you hunt? _____

*Place
Stamp
Here*

 **Hoyt**usa[®]

543 North Neil Armstrong Road
Salt Lake City, UT. 84116